



Micro Compact Directional Condenser Shotgun Video Microphone *CVM-VM10 II*
USER MANUAL **EN**

Foreword

Thanks for purchasing CoMica professional Mini Video Microphone CVM-VM10 II, it is one delicate and cardioid Mic which is fully made of Aluminum and comes with super anti-interference function; Installed with the super internal Mic, it can assist your camera and phone for professional video recording to make it to broadcasting level!

Notice

- ▲ When the Mic works with Iphone 7 or other phone with Lightning Audio input, you need to connect with the original adapter cable;
- ▲ For the IOS system smartphone (Iphone), the Mic works well either in Audio or Video mode;
- ▲ For the Android system smartphone, the Mic works well in Audio Mode; While in video mode, please try to use the video APP from the 3rd party if you find your smartphone doesn't work;
- ▲ Please don't put the device besides the heat or interference source, like radiator, Roaster or Air-condition, etc;
- ▲ Please keep this product in the dry environment;
- ▲ Do not expose this device in rain or moist environment.

In the Box List



Operation

1. Installation



As above illustration, install the Shock-absorbing stand onto the Mic body; Choose the windscreen or wind muff according to your own requirement.

2. Function

2.1 For DSLR or Micro Camera



Operation

2.2 For Smartphone

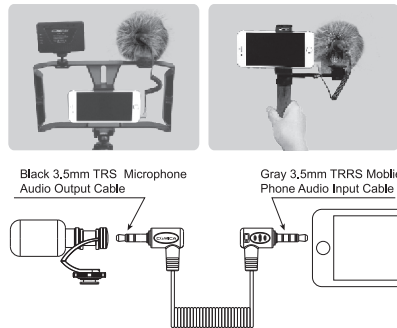

▲ Notice:

- a. When the Mic works with Iphone 7 or other phone with Lightning Audio input, you need to connect with the original adapter cable;
- b. For the IOS system smartphone (Iphone), the Mic works well either in Audio or Video mode;
- c. For the Android system smartphone, the Mic works well in Audio Mode; While in video mode, please try to use the video APP from the 3rd party if you find your smartphone doesn't work;

Specification

1. Frequency Response

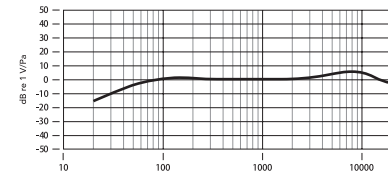

2. Polar Pattern

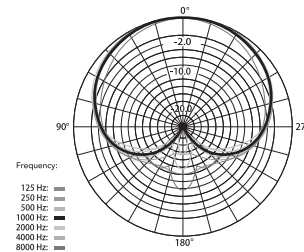

Specification

3. Technology Parameters

Polar Pattern	Cardioid
Frequency Range	60Hz~20kHz
Signal to Noise Ratio	>75dB
Maximum SPL	>105dB
Sensitivity	-33dB±2dB
Operating Voltage	1V~10V DC
Output Connection	3.5mm
Dimensions	Φ21mm x 85mm
Weight	34.2g
Working Temperature	0~50°C

Shenzhen Commlite Technology Co.,LTD
Tel: +86(0)755-28226496 Fax: +86(0)755-28435621
www.comica-audio.com support@comica-audio.com



迷你型心型指向 电容式麦克风

CVM-VM10 II
使用说明书 中文

前言

感谢您购买‘科唛COMICA’专业迷你麦克风CVM-VM10 II, 本产品是一款心型指向专业级麦克风, 设计精巧美观, 产品采用全金属材质加工而成, 具有优秀的屏蔽抗干扰能力; 搭配优质咪头设计, 可辅助手机、相机及运动相机进行视频录制并达到专业级视听效果, 让您的手机发挥超常的广电级能量!

注意事项

- ▲ 用于Lightning 音频接口的iPhone 手机时,需搭配原装 Lightning音频转换线使用;
- ▲ 该麦克风配合IOS系统 (IPHONE) 的手机使用时, 在录音及视频录制模式下均可正常工作;
- ▲ 该麦克风配合ANDROID (安卓) 系统的手机使用时, 录音模式下均可正常工作; 视频模式下, 由于大部分安卓手机没有自带外置录音功能, 需下载第三方软件配合使用。(建议使用的第三方视频软件, 如: 抖音、快手等)
- ▲ 本产品属于高精密录音设备产品, 请避免使用时掉落、碰撞或重击;
- ▲ 请在干燥环境中对该产品进行保存;
- ▲ 不要在雨中或潮湿的环境中使用该设备, 否则会有短路的危险。

物品清单



操作说明

1、安装



如上图所示, 将减震支架安装于麦克风主体上; 根据当前的环境状态自行选择防风毛或防风棉。

2、功能使用

2.1 用于相机



操作说明

2.2 用于手机

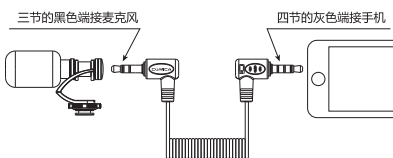
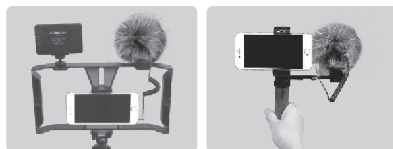

- ▲ 注:
- a. 用于Lightning 音频接口的iPhone 手机时,需搭配原装 Lightning 音频转换线使用;
 - b. 该麦克风配合IOS系统 (IPHONE) 的手机使用时, 在录音及视频录制模式下均可正常工作;
 - c. 该麦克风配合ANDROID (安卓) 系统的手机使用时, 录音模式下均可正常工作; 视频模式下, 由于大部分安卓手机没有自带外置录音功能, 需下载第三方软件配合使用。(建议使用的第三方视频软件, 如: 乐秀、美拍、小影等)

规格参数

1、频率响应

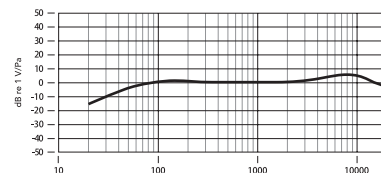

2、极性图

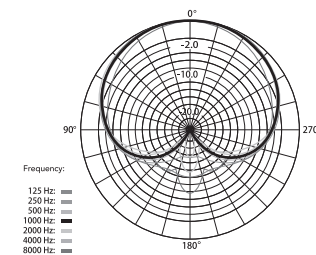

规格参数

3、性能参数

指向性	心型
频响	60Hz~20kHz
信噪比	>75dB
最大声压级	>105dB
灵敏度	-33dB±2dB
工作电压	1V~10V DC
输出接口	3.5mm
尺寸	Φ21mm x 85mm
净重	34.2g
工作温度	0~50°C

Shenzhen Commlite Technology Co.,LTD
Tel: +86(0)755-28226496 Fax: +86(0)755-28435621
www.comica-audio.com support@comica-audio.com